

"ПИТАНИЕ
220В, 50Гц"

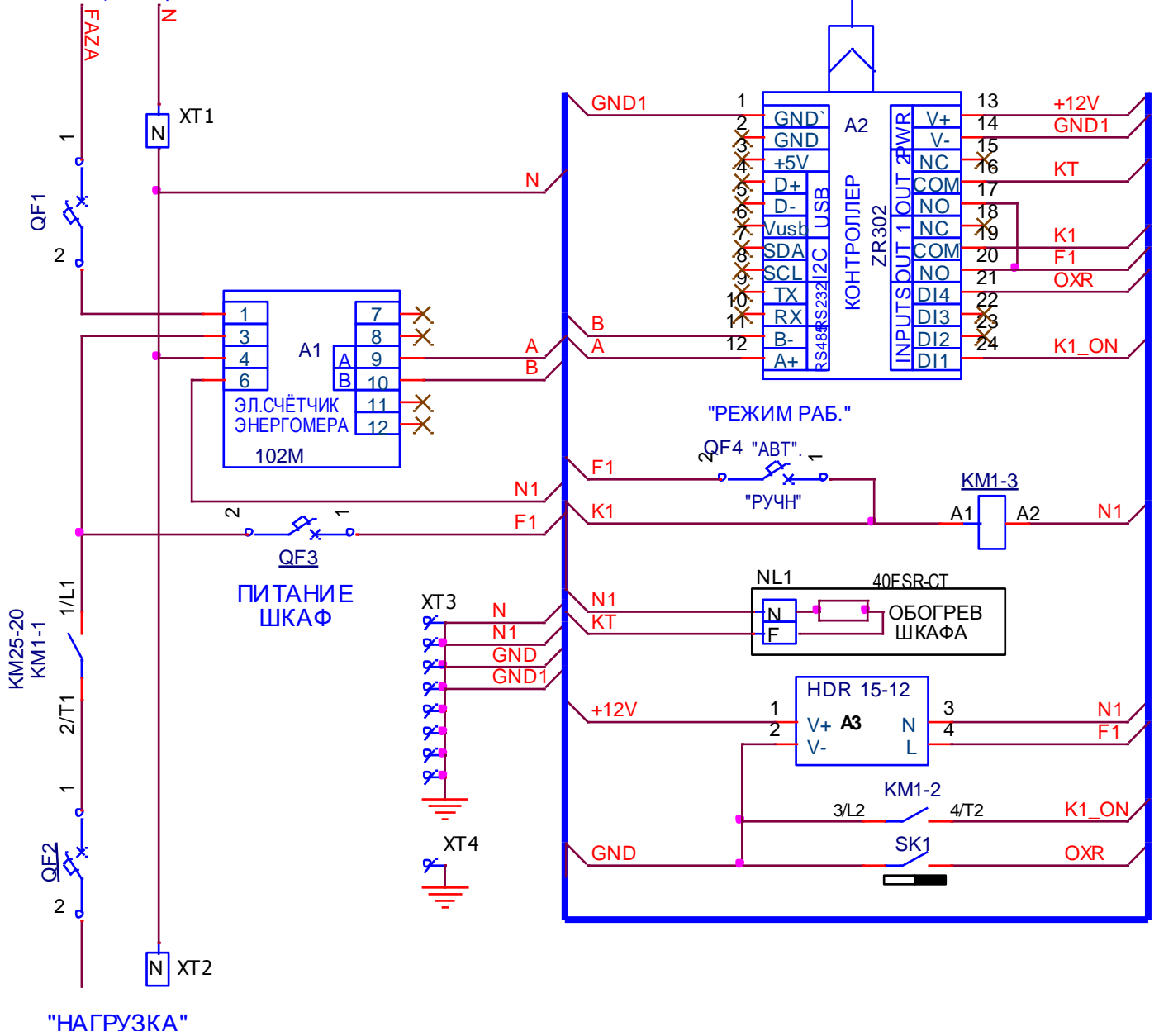

ШУО СПЕКТР 1/25А/1Пх1-МТ-220

